

WHERE PERFORMANCE MEETS SUPPORT

We recognize the importance of proving ourselves every day. All of the associates of *Action SuperAbrasive Products* are dedicated to providing the highest quality superabrasive product available to the domestic and worldwide market. We pledge a commitment to fairness and integrity in the process of continuous personal and company improvement in serving our customers, suppliers, communities, associates and their families. Grinding is found to be the foundational process in almost everything we see and touch. Therefore, its importance can not be overstated.

"Promises kept. Deadlines met. Performance delivered."











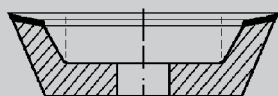
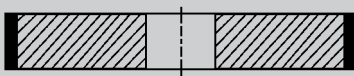
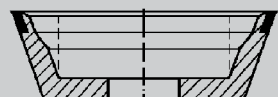
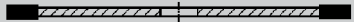

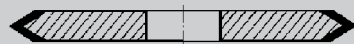

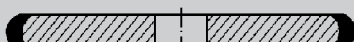

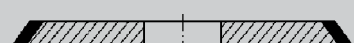

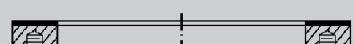

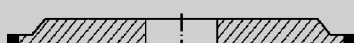
USA phone 330 673 7333 | fax 800 725 5541 / 330 673 9414 | website actionsuper.com
SWITZERLAND phone +41 32 757 37 85 | website actionsuper.ch

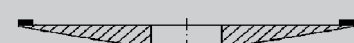
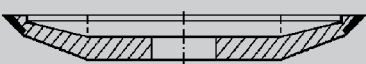
INTRO

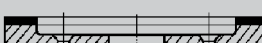
Since starting as a superabrasive wheel manufacturer with focused intent on satisfying the needs of one of the largest cutting tool manufacturers in the country, Action SuperAbrasive has grown to become an industry leader through excellent design, advanced formulation, and superior craftsmanship resulting in satisfied customers.

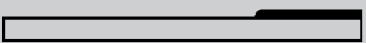
Our years of experience in the superabrasives industry provide our customers with the highest, most consistent quality diamond and CBN wheels available. We do it right the first time and deliver when you need it!

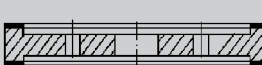
TABLE OF CONTENTS

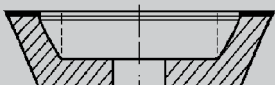
TYPE	PRODUCT SHAPE	PAGE	TYPE	PRODUCT SHAPE	PAGE
1A1		PAGE 7	11V4		PAGE 16
1A1 CENTERLESS GRINDING		PAGE 7	11V9		PAGE 16
1A1R		PAGE 7	12A2		PAGE 16
1EE1		PAGE 8	12V4		PAGE 19
1FF1		PAGE 8	12V9		PAGE 19
1V1		PAGE 8	14A1		PAGE 19
2A2T		PAGE 11	15A2		PAGE 20
3A1		PAGE 11	15V4		PAGE 20
4A2P		PAGE 11	15V9		PAGE 20
6A2		PAGE 12	W8		PAGE 21
6A2C		PAGE 12	1A8		PAGE 21
6A2H		PAGE 12	HH1		PAGE 21
6A9		PAGE 15	HH2		PAGE 21
9A3H		PAGE 15	DRESSING STICKS		PAGE 20
11A2		PAGE 15			



THE DESIGN

Listening is the first step in good design.

THE CRAFTSMANSHIP

The result of a craftsman never settling for "good enough."

THE RIGHT FORMULATION

A perfect balance of appropriate relationships.

CUSTOMERS FIRST

The approach has been simple from the start: satisfy the customer and everything else falls into place.

THE DESIGN



“ With Action, it’s more than just talk. They really listen. ”

THE DESIGN

Listening is the first step of good design. The grinding industry is an ever-changing community and the participants expect their partners to deliver the most advanced, performance-driven value for their situation or challenge. In order to produce the solution for those who put their trust in us, we first have to listen for the particulars that represent the challenge in the application. Whether the goal is finish, form retention, temperature, grind ratio, or any number of other desirable results, Action SuperAbrasive Products has been solving for these conditions for what is now over thirty years, with proven results, surpassing the expectations of those we have been privileged to partner with through the years.

Using our experience and application knowledge, our design team will work with you to develop the exact wheel composition to fit your unique conditions in your application. If you have an existing design, then ASA will manufacture wheels to your specifications. If one of our standard wheel configurations does not meet your requirements, we welcome the opportunity to quote price and delivery for a specific known geometry or work together to develop what will best serve your situation.

Action SuperAbrasive Products is one of only a few in the superabrasive industry capable of producing up to **36” continuous rim** wheels. Going beyond, we currently provide some of the largest centerless and fine-grinding wheels fitting Stahli’s, Peter Wolters, and other grinding machines.

Whether your wheel is large or small, we make them all. Allow us the opportunity, and give us a call!

WHEELS

TYPE 1A1

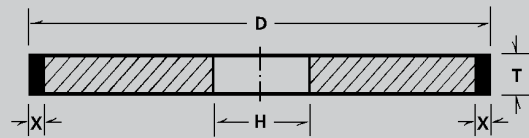

(Up to 36" in diameter in any thickness)

- Straight-Diamond or CBN in Periphery
- Available in 75, 100 and 125 Diamond Concentration
- Special Arbor Hole size upon request

TYPE 1A1 CENTERLESS GRINDING

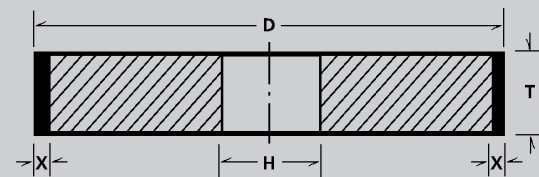

(Up to 36" in diameter in any thickness)

- Straight-Diamond or CBN in Periphery
 - Centerless Grinding Wheel for Wet or Dry Applications
 - Special Arbor Hole Size Upon Request
- (Specify diameter, thickness, concentration, grit size, and type of machine used. Mounting and balancing service is also available.)

TYPE 1EE1

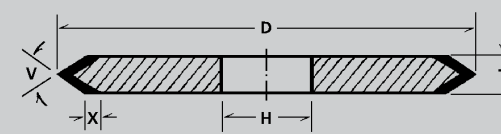

(Up to 30" in diameter in any thickness)

- Straight "EE" Face-Diamond or CBN in Periphery
 - Multiple Abrasive Depths Available
- (Special included angle "V" available upon request)

TYPE 1FF1

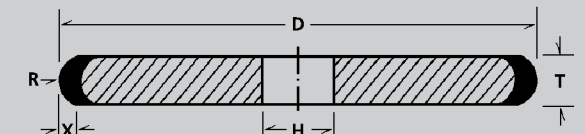

(Up to 30" in diameter in any thickness)

- Straight "FF" Face-Diamond or CBN in Periphery
 - Standard Radius is One-Half the Thickness Unless Otherwise Specified
- (Special radius "R" available upon request)

TYPE 1A1R

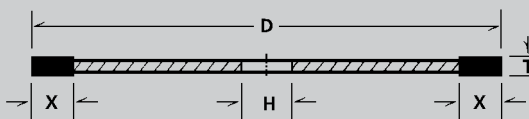

(Up to 36" in diameter in any thickness)

- Diamond or CBN in Periphery
- Standard Cut-Off and Slotting Wheels
- Steel Core/Continuous Rim Sides Relieved

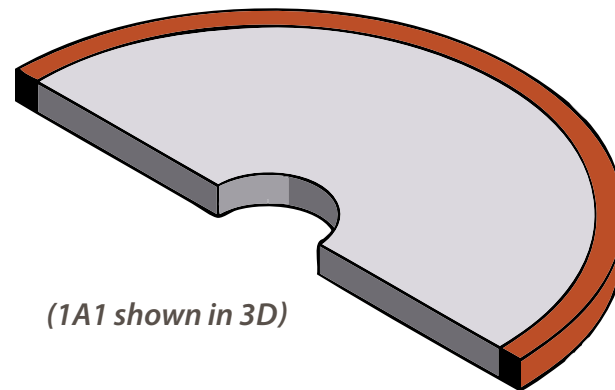

(1A1 shown in 3D)

D = Wheel Diameter
H = Hole Diameter as required
T = Wheel Thickness
X = Diamond Depth

TYPE 1V1

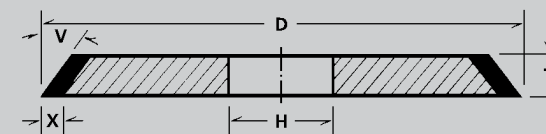

(Up to 30" in diameter in any thickness)

- Straight "V" Face-Diamond or CBN in Periphery
 - Please Specify Angle From Outside Diameter
 - Wheels Used for Gashing, Relieving, and Fluting
- (Any angle "V" available upon request)

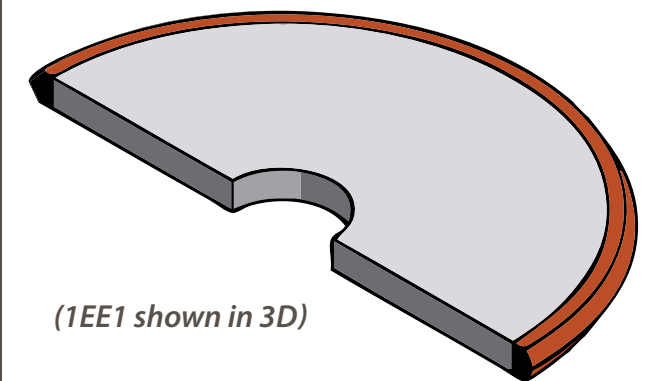

(1EE1 shown in 3D)

D = Wheel Diameter
H = Hole Diameter as required
R = Radius on Face
T = Wheel Thickness
V = Fade Angle
X = Diamond Depth

THE RIGHT FORMULATION

“ The wheels work the way they’re supposed to, when they’re supposed to! ”



THE RIGHT FORMULATION

By putting together multiple components of the highest quality in appropriate relationships or structures, according to a formula, Action SuperAbrasive Products continues to produce Diamond and CBN solutions, considered to be among the best in the grinding industry.

We often refer to superabrasive grinding wheels in three broad classifications: the hub, the secondary, and the primary. Each of these classifications allow for multiple choices to be made within themselves, with each of the choices bringing a unique effect to the grind. A range of materials available for the hub: copper, steel, powdered or cast aluminum, Bakelite, and others, can bring the desired effects of rigidity, heat dissipation, absorption, and other effects depending on the desired objective of the work being done. The same is true regarding the selection of elements for the secondary, or the varied options of behavior throughout the families of crystals. All of these decisions must be made in proper balance to one another, based on a proven knowledge of the outcome, if the result is going to satisfy the professional in today’s demanding world of tolerances.

Our proven knowledge and years of experience in superabrasive grinding can be applied toward the proper balance in formulation for your wheel today. Feel free to call or contact us online.

The perfect balance of appropriate relationships, laid upon a foundation of quality.

WHEELS

TYPE 3A1

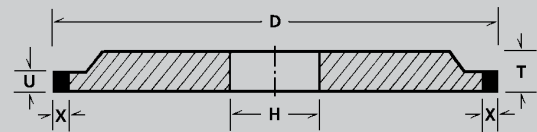

(Up to 36" in diameter in any thickness)

- Straight-Diamond or CBN in Periphery
- Specify Hole Diameter When Ordering
- Any Diamond Thickness ("U" Dimension), Including Decimals, Are Available
- 3V1 Angle Wheel Also Available

TYPE 2A2T

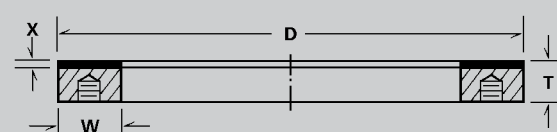

(Up to 36" in diameter in any thickness)

- Cylinder-Threaded Mounting Holes-Diamond or CBN in Rim
- Face Style Wheels Available for Blanchard, and Other Grinders
- Specify Bolt Circle and Hole Size

TYPE 6A2

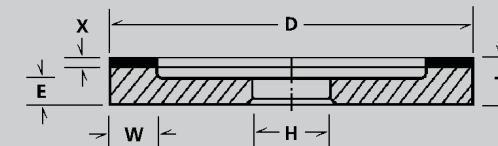

(Up to 36" in diameter in any thickness)

- Plain Cup-Diamond or CBN in Rim
 - Additional Rim Widths Available Upon Request
- (Diamond depth of 1/4" available upon request)

TYPE 6A2C

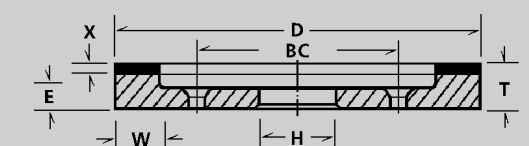

(Up to 36" in diameter in any thickness)

- Plain Cup With Countersunk Bolt Holes-Diamond or CBN in Rim
 - Specify Bolt Hole Diameter and Number
 - Additional Rim Widths Available Upon Request
- (Diamond depth of 1/4" available upon request)

TYPE 4A2P

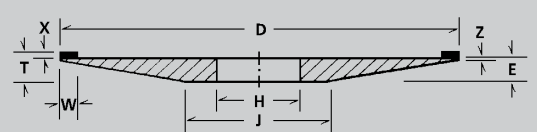

(Up to 36" in diameter in any thickness)

- Dish-Diamond or CBN in Periphery
- Dish Wheel for Facing Operations
- Alterations To Fit Widma, Vollmer and Akemat Machines Quoted Upon Request

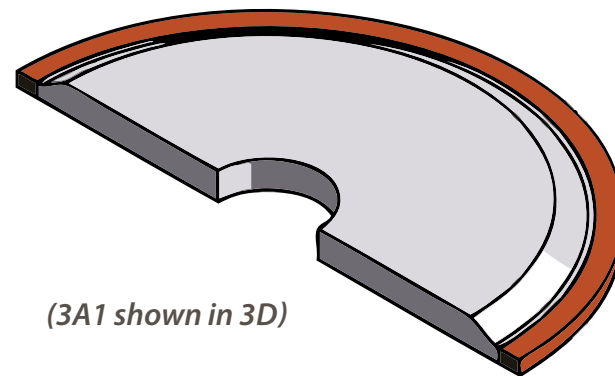

(3A1 shown in 3D)

TYPE 6A2H

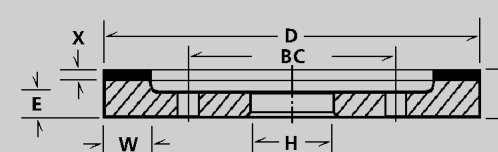

(Up to 36" in diameter in any thickness)

- Plain Cup With Bolt Holes-Diamond or CBN in Rim
 - Specify Bolt Hole Diameter and Number
 - Additional Rim Widths Available Upon Request
- (Diamond depth of 1/4" available upon request)

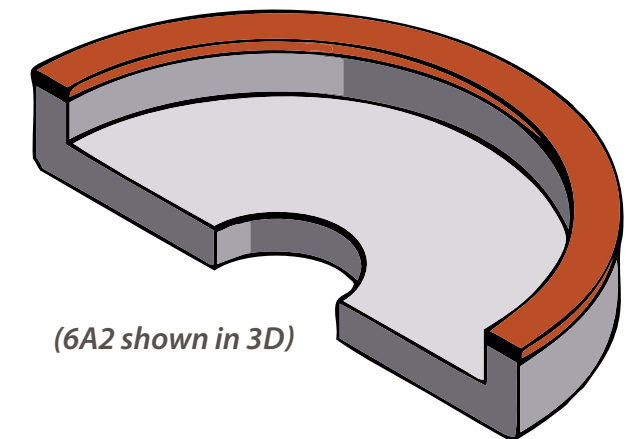

(6A2 shown in 3D)

D = Wheel Diameter
 E = Back Thickness
 H = Hole Diameter as required
 J = Back Flat Diameter
 T = Wheel Thickness
 U = Diamond Thickness
 W = Rim Width
 X = Diamond Depth
 Z = Preform Thickness at Rim

D = Wheel Diameter
 E = Back Thickness
 H = Hole Diameter as required
 T = Wheel Thickness
 W = Rim Width
 X = Diamond Depth

THE CRAFTSMANSHIP



“ I don't have to worry whether one wheel will behave differently from another. ”

THE CRAFTSMANSHIP

Craftsmanship is the result of the work of a craftsman. Which leads to the question of, “what is a craftsman?”

Doing what you're good at, and mastering that.

The term “craftsman” applies to someone who has focused their life on a certain material and a certain realm of tools and processes that really define an art form.

It's being devoted to your skill, making something that will make an impact in the life of someone else. Making something that stands above others in its category; that has character in the way that it responds to the task where it is being employed.

Craftsmanship is reflected in the relationship between those that were involved in producing the wheel and the smile on the face of the individual using it. Taking pride in what you do while always learning to improve.

Being a craftsman is being hands-on & getting deep into what you are doing. It's constantly asking questions. Demanding more. How? How can I improve what I'm currently making or how I'm making it? What? What is the end-user doing with it and what changes can I introduce that will improve that experience for them? What innovations have occurred since this process began that I can implement resulting in improvements? Why? Is there a better way?

The skilled craftsmen that make up our team demonstrate their expertise in the superior quality of our products. When combined with the latest in equipment, our associates produce grinding wheels with the superb performance and dimensional accuracy our customers have come to expect.

WHEELS

TYPE 6A9

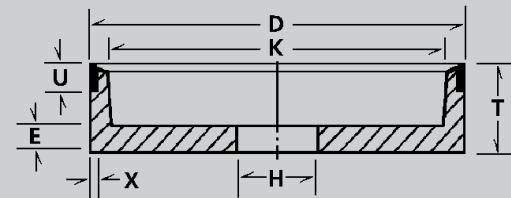

(Up to 36" in diameter in any thickness)

- Plain Cup-Diamond or CBN in Periphery
(Twin Grit or Dual Grit available upon request)

TYPE 9A3H

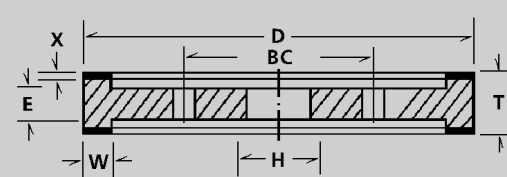

(Up to 36" in diameter in any thickness)

- Diamond or CBN in Rim
- Dual face style grinding wheel
- For no bolt pattern, specify Type 9A3

TYPE 11V4

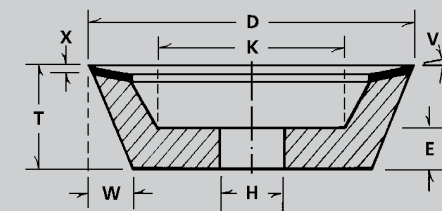

(Up to 36" in diameter in any thickness)

- Flaring Cup-Rim Beveled Inside Diamond or CBN in Rim

TYPE 11V9

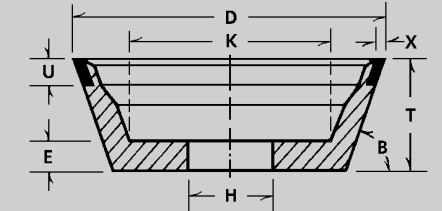

(Up to 8" in diameter in any thickness)

- Flaring Cup-Diamond or CBN in Periphery
(20mm arbor hole for decimal grinders available upon request)

TYPE 11A2

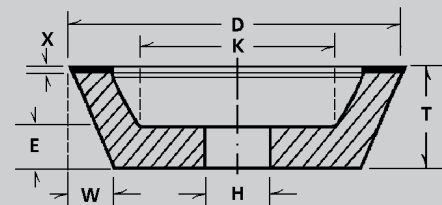

(Up to 36" in diameter in any thickness)

- Flaring Cup-Diamond or CBN in Rim
- Additional Diameters and Rim Width Available Upon Request

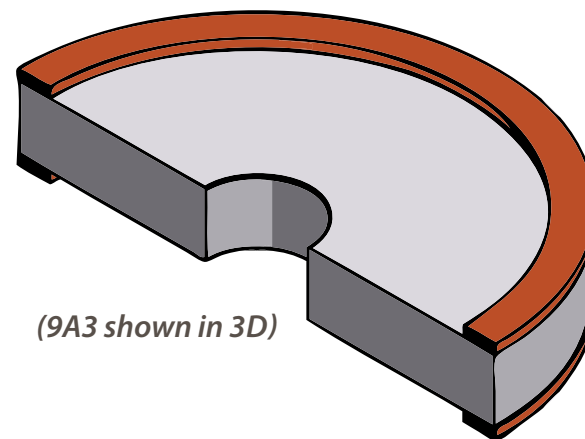

(9A3 shown in 3D)

TYPE 12A2

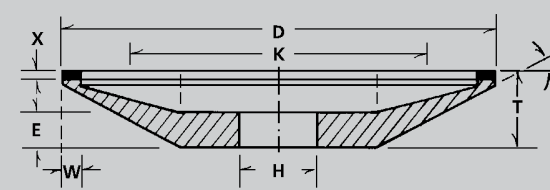

(Up to 36" in diameter in any thickness)

- Dish-Diamond or CBN in Rim

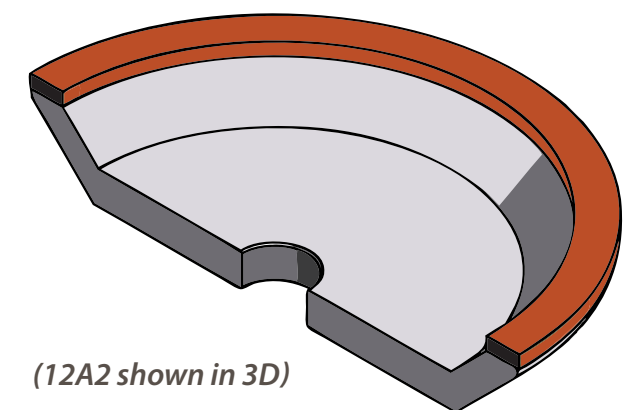

(12A2 shown in 3D)

D = Wheel Diameter
E = Back Thickness
H = Hole Diameter as required
K = Inside Flat Diameter
T = Wheel Thickness
U = Insert Length
W = Rim Width
X = Diamond Depth

B = Hub Angle
D = Wheel Diameter
E = Back Thickness
H = Hole Diameter as required
K = Inside Flat Diameter
T = Wheel Thickness
U = Insert Length
V = Rim Angle
W = Rim Width
X = Diamond Depth

CUSTOMERS FIRST



// They've been there for me, even on a weekend, just to help me with an application! //



THE CUSTOMER COMES FIRST

The approach has been simple from the start: satisfy the customer and everything else falls into place.

At Action SuperAbrasive Products, to provide the best service for those that privilege us with the opportunity, every day is spent focusing all our efforts on providing superabrasive grinding solutions that will produce superior products in the markets where they exist.

We're aware there are several options for superabrasive grinding solutions. When maximum performance has been realized, our service has to be the best. We realize our sole reason of existence is our customer. Our commitment is to treat everyone that trusts in Action SuperAbrasive Products with respect, honesty, integrity, and fairness, without discrimination.

Give us a call today and allow our trained, professional team to offer technical solutions and ordering assistance, satisfying you with the performance you need, when you want it.

Promises kept, deadlines met, performance delivered!

WHEELS

TYPE 12V4

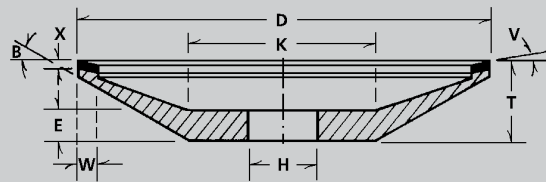

(Up to 36" in diameter in any thickness)

- Dish-Rim Beveled Inside Diamond or CBN

TYPE 12V9

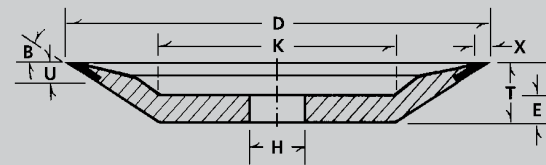

(Up to 20" in diameter in any thickness)

- Diamond-Dish or CBN in Periphery
- Please Specify Angle From Outside Diameter

TYPE 15A2

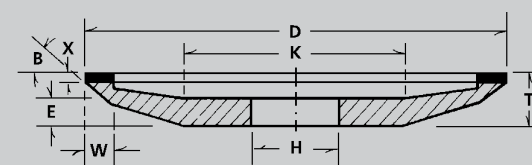

(Up to 36" in diameter in any thickness)

- Dish-Diamond or CBN in Rim

TYPE 15V4

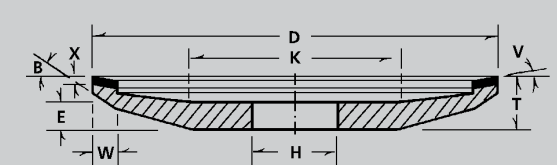

(Up to 36" in diameter in any thickness)

- Dish-Rim Beveled Inside Diamond or CBN in Rim

TYPE 14A1

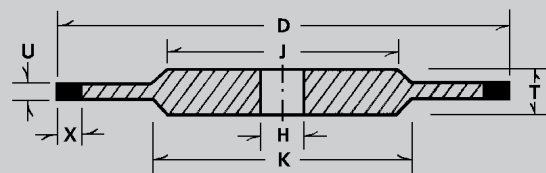

(Up to 36" in diameter in any thickness)

- Straight Wheel With Hub On Each Side, Diamond or CBN Periphery
- (1/4" diamond depth available upon request)

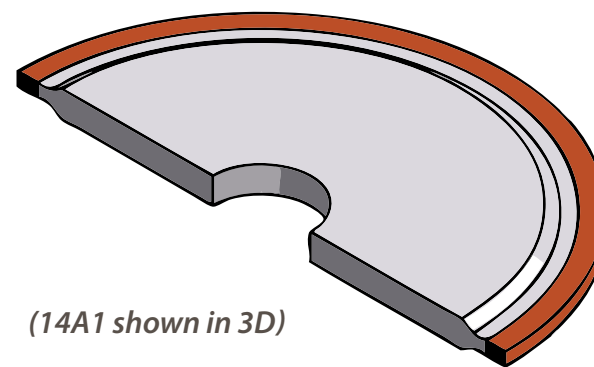

(14A1 shown in 3D)

TYPE 15V9

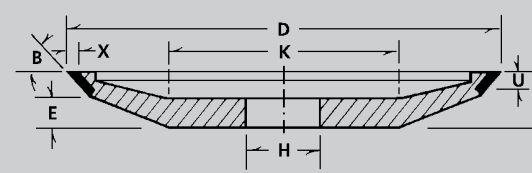

(Up to 20" in diameter in any thickness)

- Dish-Diamond or CBN in Periphery
- Please Specify Angle From Outside Diameter

DRESSING STICKS

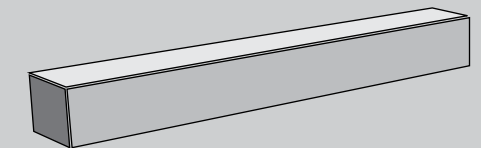

- Aluminum Oxide Dressing Sticks
- Other Sizes Available Upon Request
- Silicon Carbide Dressing Sticks Also Available

We can supply wheel adapters and flanges.
Contact us for more information.

B = Hub Angle
D = Wheel Diameter
E = Back Thickness
H = Hole Diameter as required
J = Hub Diameter
K = Inside Flat Diameter
T = Wheel Thickness
U = Diamond Thickness
U = Insert Length
V = Rim Angle
W = Rim Width
X = Diamond Depth

B = Hub Angle
D = Wheel Diameter
E = Back Thickness
H = Hole Diameter as required
K = Inside Flat Diameter
T = Wheel Thickness
U = Insert Length
V = Rim Angle
W = Rim Width
X = Diamond Depth

WHEELS

TYPE W8

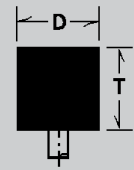

(Up to 5" in diameter in any thickness)

- Mounted or Mandrel Straight Diamond or CBN throughout
(Special shanks available upon request)

TYPE 1A8

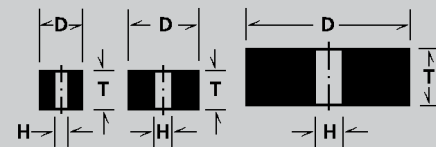

(Up to 5" in diameter in any thickness)

- Straight-Diamond or CBN Throughout
- I.D. Grinding Wheels for Bryant, Heald
- Available in 100 Concentration Only

TYPE HH1

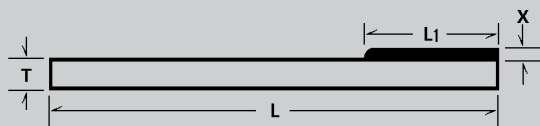

(Up to 6" in diameter in any thickness)

- Hand Hone-CBN or Diamond Insert One End

TYPE HH2

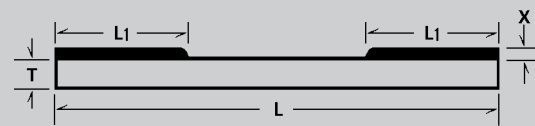

(Up to 6" in diameter in any thickness)

- Hand Hone-CBN or Diamond Inserts Both Ends

D = Wheel Diameter
H = Hole Diameter as required
L = Length
L₁ = Length Diamond Section
T = Wheel Thickness
W = Rim Width
X = Diamond Depth





“PROMISES KEPT. DEADLINES MET.
PERFORMANCE DELIVERED.”

7 easy steps



ORDERING INFORMATION

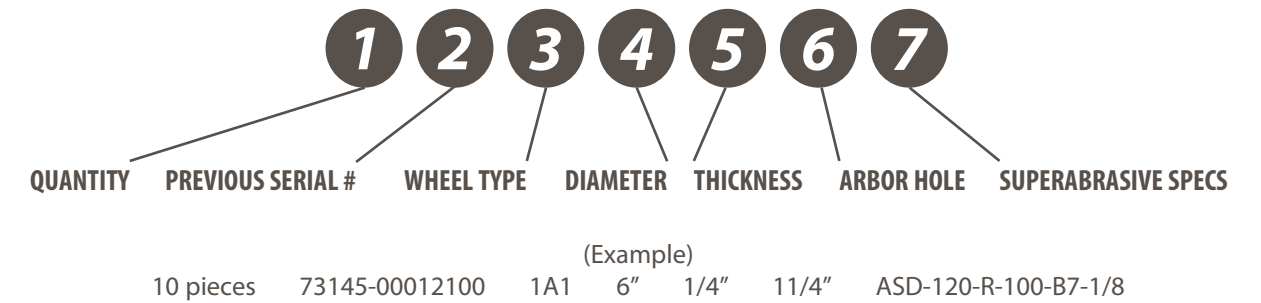

Superabrasive Specification Example: ASD-120 R100-B7-1/8

SUPERABRASIVES

ND	Natural Diamond
SD	Uncoated Synthetic Diamond
ASD	56% Nickel Coated Synthetic Diamond
ASDC	50% Copper Coated Synthetic Diamond
SSD	Synthetic Diamond for Carbide and Steel
SD3	30% Nickel Coated Synthetic Diamond
CBN	Cubic Boron Nitride (60% Nickel Coated)
MB	Metal Bond Synthetic Diamond

CONCENTRATION

50 75 **100** 125 150

BOND TYPE

Type
B-Resin M-Metal BP-Polyimide V-Vitrified
 (Please call our engineering staff to help with Bond Type for your applications)

FINISHING SPECIFICATIONS

Grit Size (U.S.)	Expected Finish (Micro-inches)	FEPA (European)
60	30-36	D252
80	24-30	D181
100	18-24	D151
120	16-18	D126
150	14-16	D107
180	12-14	D91
220	10-12	D76
240	8-10	D64
320	8	D54
400	7-8	D46
500	7	D40
600	6-7	D35
800	6	D25
1200	5-6	D15

Modification

- Surface Grinding and Tool and Cutter Grinding (Wet)
- Surface Grinding and Tool and Cutter Grinding (Dry)
- Flute and Plunge Wet Grinding
- Cylindrical and Internal Wet Grinding
- Centerless Grinding

DEPTH OF SUPERABRASIVES

1/16" **1/8"** 1/4" 3/8" 1/2" 1" 2"

REQUEST FOR CUSTOM WHEEL QUOTATION

To expedite price and delivery information for Custom Action SuperAbrasive's Diamond/CBN Grinding Wheels, please photocopy this page and provide the required information.

CUSTOMER INFORMATION

Company Name _____
Address _____
City _____ State _____ Zip _____
Contact Name _____
Department _____ Phone _____ Fax _____

MACHINE OPERATING PERFORMANCE

Machine Name _____ Type _____
Spindle: H.P. _____ RPM _____
Operation Wet Dry
(If wet, how much coolant pressure is available?) _____

Statement of Objectives:
(e.g., finish, cycle time and wheel life)

MATERIAL BEING GROUND

Carbide _____ Steel _____
Grade _____ Type _____
Cobalt % _____ Hardness _____

Other Information:

PROFILE SPECIFICATIONS

If drawing is available, please attach. If not, use this graph to sketch and document the following:

- Diameter and tol _____
- Thickness and tol _____
- Arbor hole size _____
- Any radii, angles, specific shapes, etc. _____

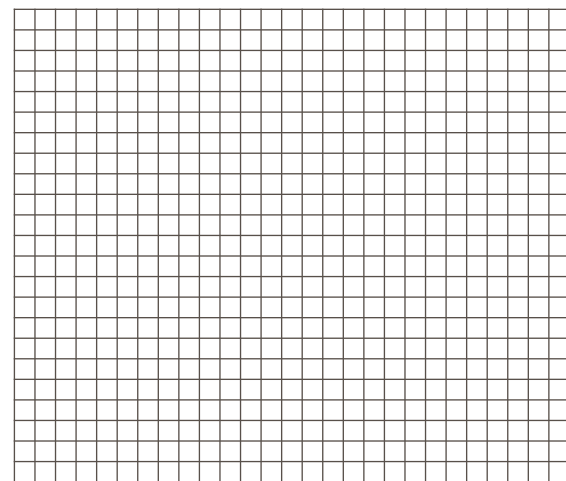

WORLDWIDE PRODUCTION



-  Automotive
-  Cutting Tools
-  Oil & Gas
-  Medical
-  Aerospace
-  Technology
-  Defense





"Promises kept. Deadlines met. Performance delivered."

945 GREENBRIAR PARKWAY KENT, OHIO 44240
ACTIONSUPER.COM / 330 673 7333

CHEMIN DES PRÉS-BERSOT, SWITZERLAND
ACTIONSUPER.CH / +41 32 757 37 85